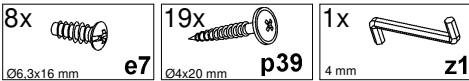
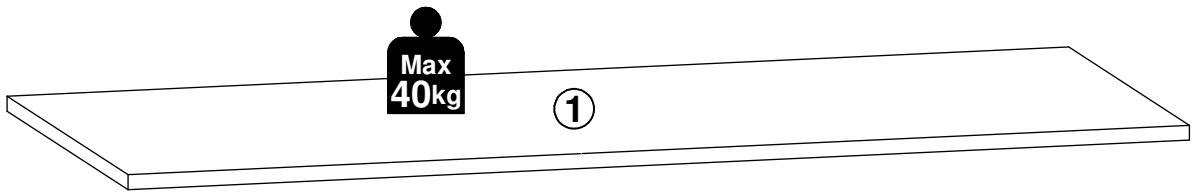
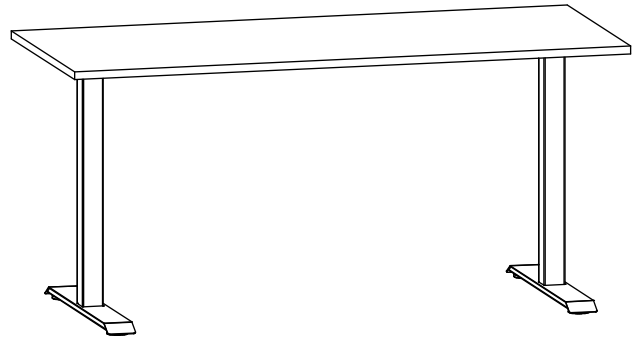
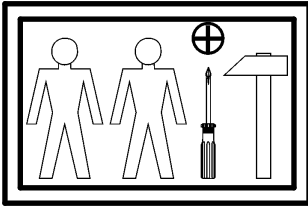
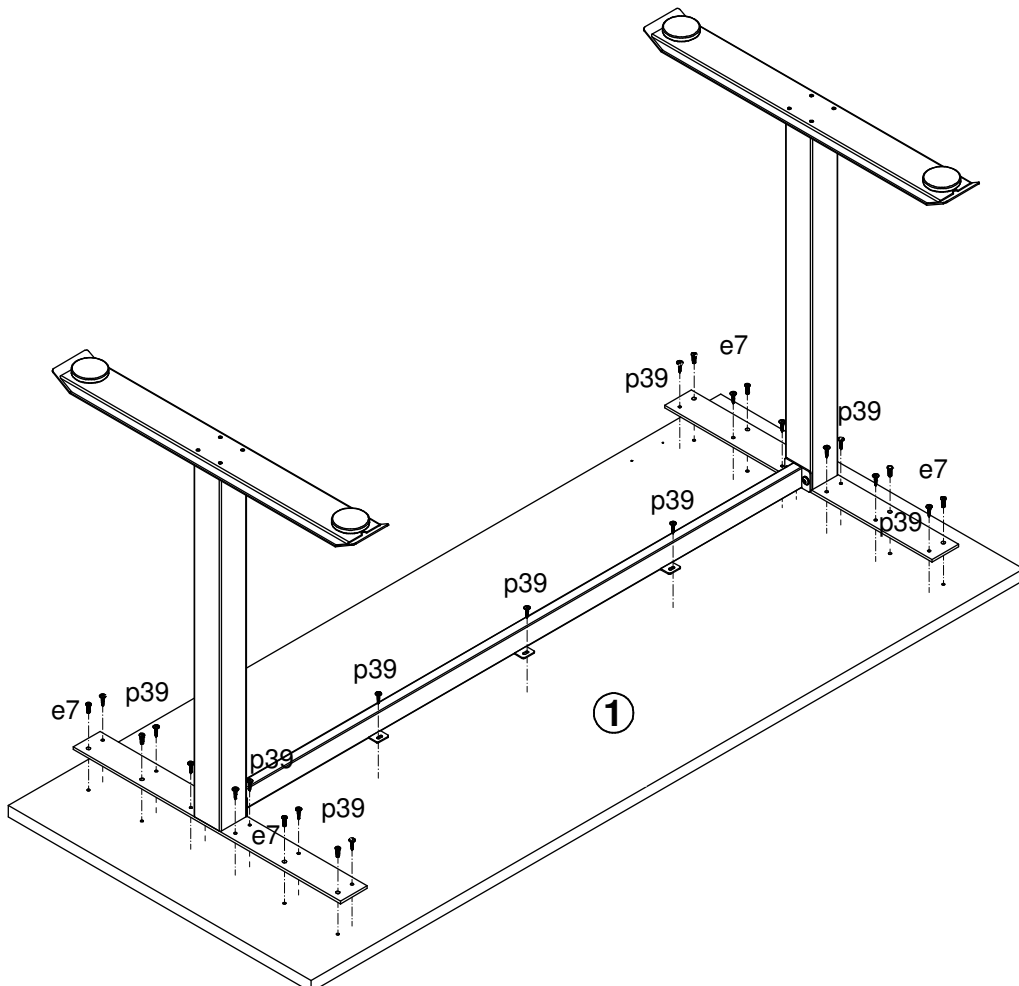

A**OFFICE SPACE S479-BIU/160/68/A**

A	B	C	D
1	S479-2024	1600	680
			1/3

1 

A**OFFICE SPACE S479-BIU/160/68/B**

A	B	C	D
1	S479-2024	1600	680 1/2

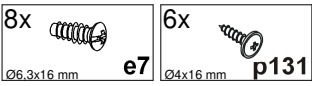
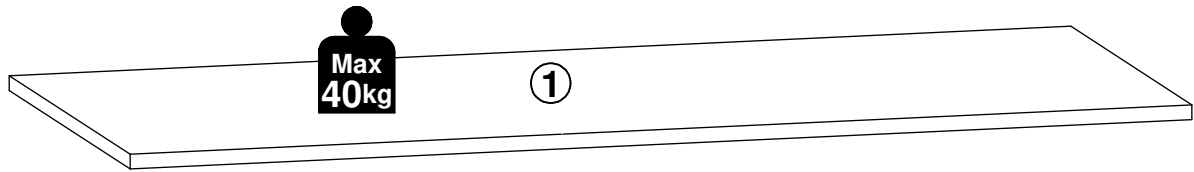
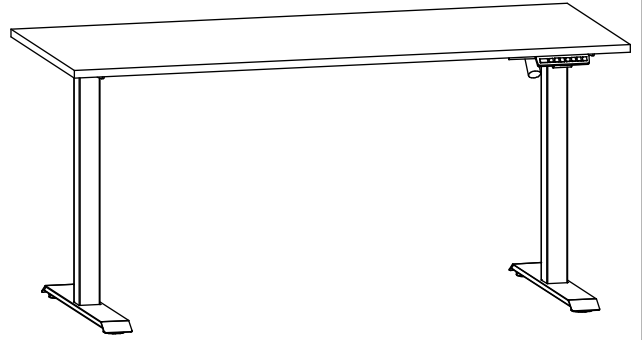
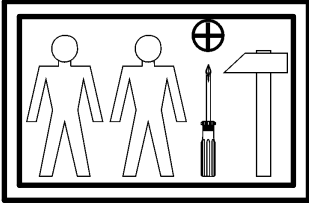
**1** 